

BRAIN GAMES

GAME PROGRAM™ INSTRUCTIONS

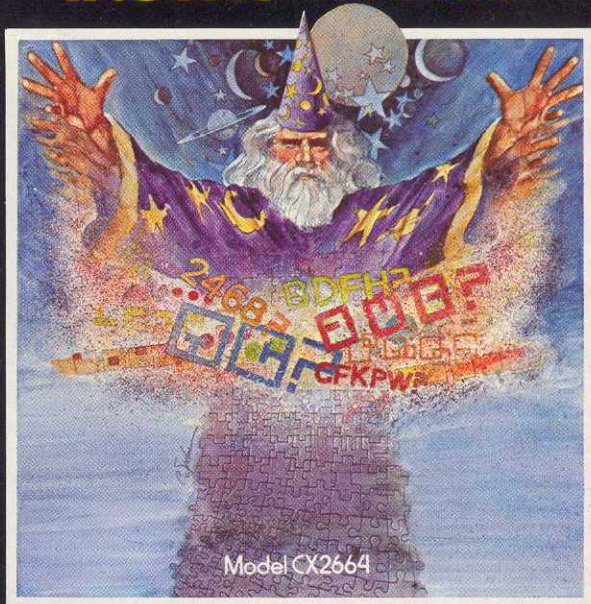

A Warner Communications Company

ATARI, INC., Consumer Division
1195 Borregas Ave., Sunnyvale, CA 94086

BRAIN GAMES

Use your Keyboard Controllers with this Game Program™. Be sure the controller cable is firmly plugged into the jacks on the rear of your Video Computer System. See your Owner's Manual for details. For one-player games, use the left controller. To prolong the life of your Atari Video Computer System and to protect the electronic components, the Console unit should be OFF when inserting or removing a Game Program.

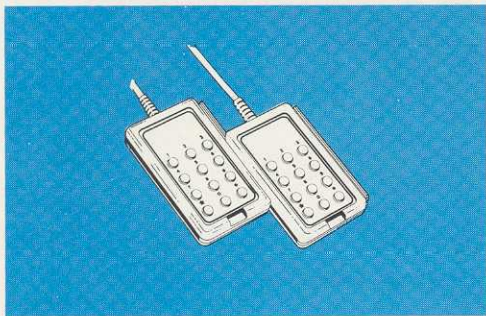

TOUCH ME™

Games 1 to 4

The computer plays a “sequence of tones” which you must match, starting with one tone and adding a new tone to the sequence each time you enter correctly.

As the computer is playing the sequence, the word WAIT will appear at the top of the screen. When the computer says GO, it is your turn to match the tone sequence. If you miss the sequence, the computer will say WAIT, repeat the sequence, and credit you with a “miss”. Four “misses” (or correctly following a sequence of 32 tones) completes the game.

The number in the box at the top of the screen is the number of tones that have been correctly played.

In two-player games, the players alternate. As one player enters the sequence correctly, a new tone will be added for the other player. The computer will say GO underneath the score of the player whose turn it is. The game ends when either player reaches four “misses”, or if both players correctly complete a 32-tone sequence.

The word "GO" is displayed in a pixelated, black font on a yellow rectangular background.The word "WAIT" is displayed in a solid black font on a yellow rectangular background.The word "TOUCH" is displayed in a pixelated, black font on a yellow rectangular background.

USING THE KEYBOARD CONTROLLER

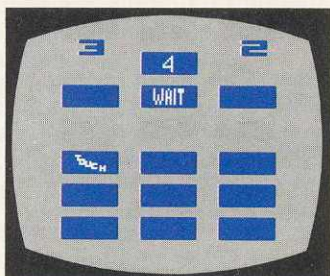
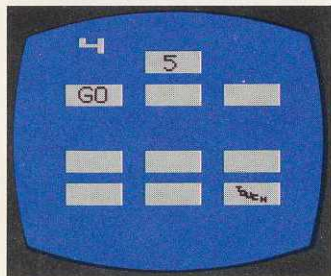

As shown in the diagram above, the six boxes at the bottom of the screen correspond to numbers 1 to 6 on your controller. In the 9-tone games, the nine boxes at the bottom of the screen correspond to the numbers 1 to 9 on your controller.

DIFFICULTY SWITCHES

In the **A** position, the player will not hear the entire tone sequence, but only the new tone that is added. If a miss is made, the computer will then play the entire sequence. In **B** position, the tone sequence is repeated each time, with the new tone added.

COUNT ME Games 5 to 8

Play this game like TOUCH ME™. The computer will play a sequence of digits to be matched in order. The computer adds a new digit to the sequence when you correctly follow the sequence.

When the computer shows you the sequence in the box at the center of the screen, the word WAIT will appear. When the computer says GO, it is your turn to match the sequence. If you miss, the computer will say WAIT, repeat the sequence, and credit you with a "miss". Four "misses" (or correctly following a sequence of 32-digits) completes the game.

The number in the box at the top of the screen shows the number of digits in the sequence that you have correctly followed.

Players alternate for two-player games. As one player correctly identifies the sequence, a new digit is added for the next player. The computer will say GO underneath the score of the player whose turn it is. The game ends when either player scores four "misses" or if both players correctly complete a sequence of 32-digits.

USING THE KEYBOARD CONTROLLER

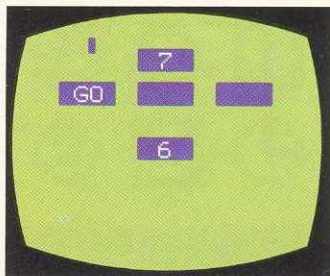

As the computer generates the sequence, enter the digits, in order, by pushing the corresponding number on your Keyboard controller.

DIFFICULTY SWITCHES

When your Difficulty Switch is in the **B** position, the computer will show you the complete sequence of digits to be followed. In the **A** position, the computer will not show the entire sequence, but only the digit that has been added. If a "miss" is made, the computer will then refresh your memory by showing the entire sequence.

PICTURE ME™ Games 9 and 10

In these one-player games, the computer will display a set of four objects in the center column. While the computer makes a distracting noise, try to memorize the order of the objects from top to bottom. The computer then scrambles the order, moves them to the lefthand column, and gives you twenty seconds to remember their original order.

In game 9, you have four seconds to memorize the original order of the objects, in Game 10 you have 1½-seconds.

If your guess is incorrect or the time runs out, the computer will show you the correct answer in the lefthand column, before showing the next set of objects.

You get one point for each object placed in the correct position and a bonus score based on the time taken to

remember all the objects.
Five sets of objects are a game.

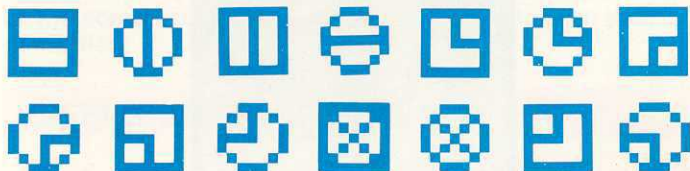

USING THE KEYBOARD CONTROLLER

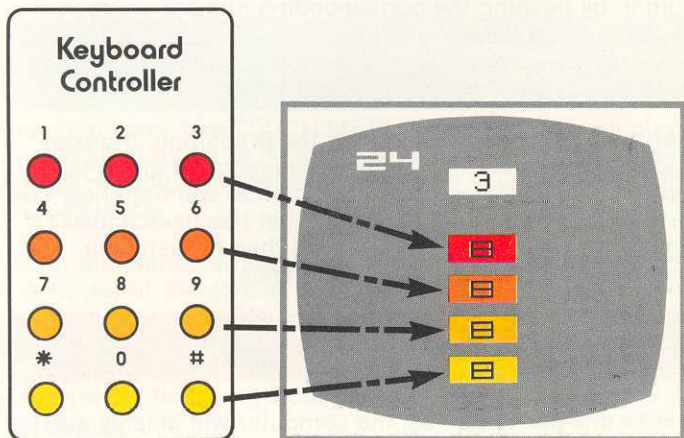

Each row of numbers on your controller corresponds with one of the boxes on the screen. For example, row one (numbers 1-2-3) corresponds with the top box; row two (numbers 4-5-6) corresponds with the second box, etc. If the first object in the center column was scrambled to the second box in the left column, push a button in row two of your Keyboard (number 4, 5, or 6). That object will appear in the righthand column in the first box. Continue making selections in this way.

Each object can be selected only once.

DIFFICULTY SWITCHES

In these games, the left Difficulty Switch affects the Bonus Scoring. In the **A** position, the Bonus Score added to your correct guesses is one-half the timer value. In the **B** position, the Bonus Score is equal to the timer value. The right Difficulty Switch has no effect.

The best possible score in the **A** position is 45; in **B** the best possible score is 70.

FIND ME™ Games 11 to 14

The computer generates a set of four objects on the screen. All, except one, are identical. Your score is based on the time taken to find the one dissimilar object.

You can continue to enter guesses until the timer runs out. The correct answer will show in the box at the top of the screen. There are five sets of objects per game. In Games 11 and 13 you have 20-seconds to find the dissimilar object; in Games 12 and 14 you have only 5-seconds.

In the one-player games, using the left controller, try to improve your score with each game. In two-player games, each player is competing to find the same dissimilar object and score first.

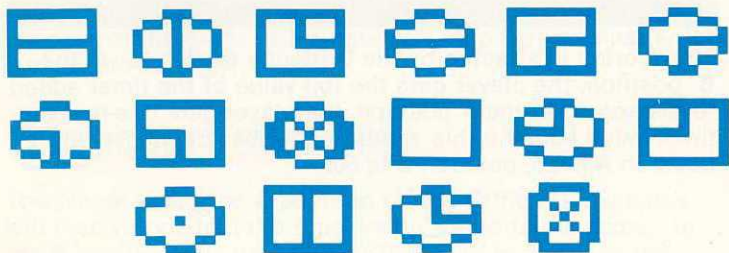

USING THE KEYBOARD CONTROLLER

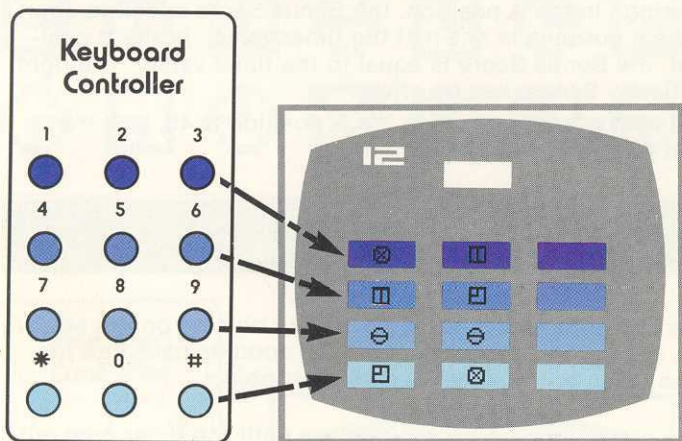

Each row of numbers on your controller corresponds with one of the boxes on the screen. For example, row one (numbers 1-2-3) corresponds with the top box; row two (numbers 4-5-6) corresponds with the second box, etc. If the dissimilar object is in the fourth box push a button in row four (*-0-#) of your controller. The correct solution to the above diagram is 3.

DIFFICULTY SWITCHES

The scoring is affected by the Difficulty Switches. In the **B** position, the player gets the full value of the timer added to his score. In the **A** position, the player gets one-half the timer value added to his score. Best possible score for position **A** is 25, position **B** is 50.

ADD ME

Games 15 to 18

A set of digits is generated by the computer. You score by adding the digits and entering the sum before the timer runs out. The correct answer will appear in the box at the top of the screen. There are five sets of digits per game.

With the left controller, continue to practice on the one-player games. In the two-player games, each player is trying to enter the sum of the same set of digits and score first.

Games 15 and 17 give you twenty seconds to find the sum of four digits. Games 16 and 18 give you five seconds to find the sum of five digits.

USING THE KEYBOARD CONTROLLER

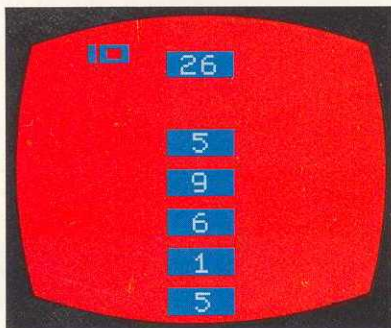

Enter your answer just as you would with a calculator. If the sum of the digits is a single unit (4 to 9), you must enter it as a zero-sum (04, 05, etc.).

DIFFICULTY SWITCHES

The player using the **A** position on the Difficulty Switches will receive one-half the timer value added to his score. In the **B** position, the full value of the timer is added to the score. Best possible score for **B** position is 50; best possible score for **A** position is 25.

PLAY ME

Game 19

Your keyboard controllers become musical instruments. Each button on the controller will generate a different musical note, allowing you to play songs. If both controllers are used, duets can be played on your Video Computer System. The Difficulty Switches have no effect on this game.

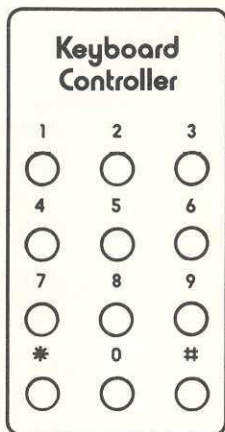
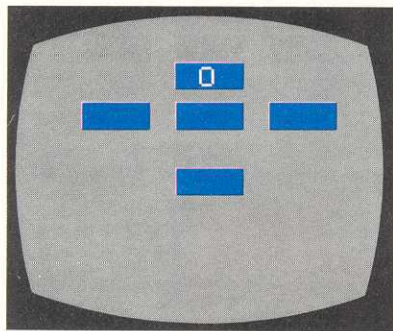

PLAY ME SONG BOOK

Press the numbers on your Keyboard Controller in order. Numbers that are underlined should be held for that count.

Happy Birthday

9-9-8-9-6-7-7-7/9-9-8-9-5-6-6/

9-9-2-4-6-7-8/3-3-4-6-5-6-6.

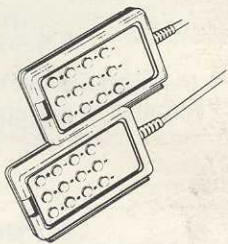

BRAIN GAMES

Use your Keyboard Controllers with this Game Program.™
 Be sure the controller cable is firmly plugged into the jacks
 on the rear of your Video Computer System.™

TOUCH ME™

Game Number	1	2	3	4
Number of Players	1	1	2	2
Tone	6	9	6	9

COUNT ME

Game Number	5	6	7	8
Number of Players	1	1	2	2
Tone/Digits	6	9	6	9

PICTURE ME™

Game Number	9	10
Number of Players	1	1
Waiting Time (Secs.)	5	3

FIND ME™

Game Number	11	12	13	14
Number of Players	1	1	2	2
Slow Time				
Fast Time				

ADD ME

Game Number	15	16	17	18
Number of Players	1	1	2	2
Digits	4	5	4	5

PLAY ME

Game Number	19
-------------	----

For 1 or 2 players. Use
 your controllers to play
 tunes.

BRAIN GAMES

ATARI® GAME PROGRAM™ INSTRUCTIONS



A Warner Communications Company



α2664

COMPLETE GAME PLAY
INSTRUCTIONS

19 GAME VARIATIONS

ONE AND TWO-
PLAYER GAMES

NOTE: Always turn the console power switch off when inserting or removing an ATARI® Game Program™ cartridge. This will protect the electronic components and prolong the life of your ATARI Video Computer System™ game. Manual, Program, and Audiovisual © 1979, ATARI, INC.

TABLE OF CONTENTS

1. USING THE CONTROLLERS	1
2. CONSOLE CONTROLS	1
3. GAME VARIATIONS	1
TOUCH ME™	1
COUNT ME™	3
PICTURE ME™	3
FIND ME™	5
ADD ME™	6
PLAY ME™	7
4. PLAY ME™ SONG BOOK	7
5. GAME SELECT MATRIX	8

1. USING THE CONTROLLERS



Use your Keyboard Controllers with this ATARI® Game Program™ cartridge. Be sure the Keyboard Con-

trollers are firmly plugged into the **CONTROLLER** jacks at the back of your ATARI Video Computer System™ game. For one-player games, use the Keyboard Controller plugged into the **LEFT CONTROLLER** jack.

Use of the Keyboard Controller varies from game to game. See the individual game variations for the appropriate use of the Keyboard Controllers.

2. CONSOLE CONTROLS

GAME SELECT SWITCH

Use the **game select** switch to select the game number you wish to play. The game number changes at the top, left side of the screen.

GAME RESET SWITCH

When you have selected the game number you wish to play, press **game reset** to start the game.

DIFFICULTY SWITCHES

Again, see the individual game variations for the appropriate use of the difficulty switches.

TV TYPE SWITCH

Set this switch to **color** if you have a color television set. Set it to **b-w** if you are playing the game in black and white.

3. GAME VARIATIONS

TOUCH ME™ **Games 1 to 4**

The computer plays a "sequence of tones" which you must match, starting with one tone and adding a new tone to the sequence each time you enter correctly.

As the computer is playing the sequence, the word **WAIT** will appear at the top of the screen. When the computer says **GO**, it is your turn to match the tone sequence. If you

ATARI® GAME PROGRAM™ INSTRUCTIONS

miss the sequence, the computer will say WAIT, repeat the sequence, and credit you with a "miss". Four "misses" (or correctly following a sequence of 32 tones) completes the game.

The number in the box at the top of the screen is the number of tones that have been correctly played.

In two-player games, the players alternate. As one player enters the sequence correctly, a new tone will be added for the other player. The computer will say GO underneath the score of the player whose turn it is. The game ends when either player reaches four "misses", or if both players correctly complete a 32-tone sequence.



DIFFICULTY SWITCHES

In the **a** position, the player will not hear the entire tone sequence, but only the new tone that is added. If a miss is made, the computer will then play the entire sequence. In **b** position, the tone sequence is repeated each time, with the new tone added.

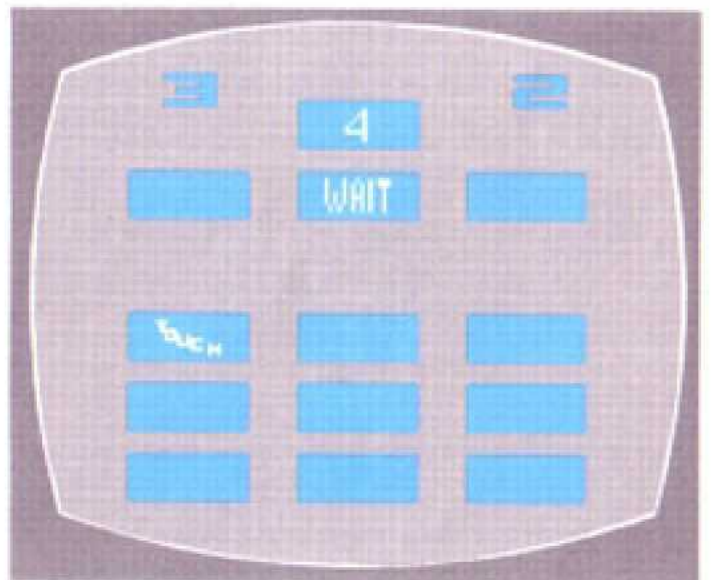
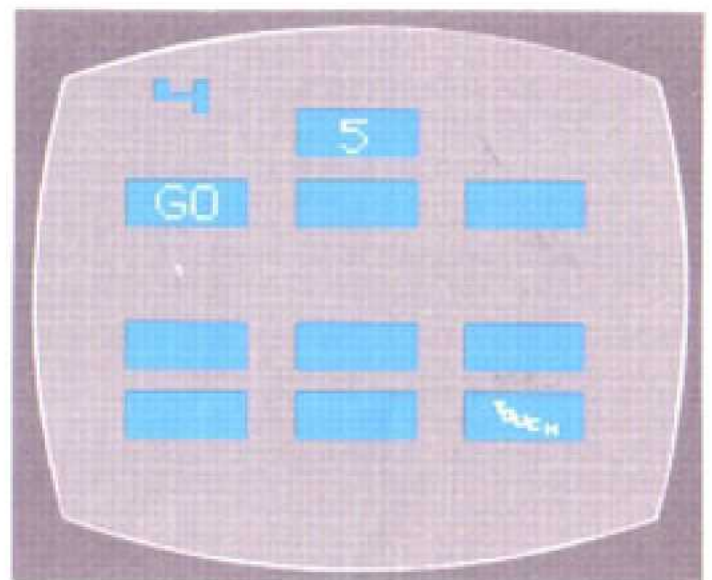

USING THE KEYBOARD CONTROLLER

As shown in the diagram above, the six boxes at the bottom of the screen correspond to numbers 1 to 6 on your controller. In the 9-tone games, the nine boxes at the bottom of the screen correspond to the numbers 1 to 9 on your Keyboard Controller.

COUNT ME™ Games 5 to 8

Play this game like TOUCH ME™. The computer will play a sequence of digits to be matched in order. The computer adds a new digit to the sequence when you correctly follow the sequence.

When the computer shows you the sequence in the box at the center of the screen, the word WAIT will appear. When the computer says GO, it is your turn to match the sequence. If you miss, the computer will say WAIT, repeat the sequence, and credit you with a "miss". Four "misses" (or correctly following a sequence of 32-digits) completes the game.

The number in the box at the top of the screen shows the number of digits in the sequence that you have correctly followed.

Players alternate for two-player games. As one player correctly identifies the sequence, a new digit is added for the next player. The computer will say GO underneath the score of the player whose turn it is. The game ends when either player scores four "misses" or if both players correctly complete a sequence of 32-digits.

USING THE KEYBOARD CONTROLLER

As the computer generates the sequence, enter the digits, in order, by pushing the corresponding number on your Keyboard Controller.

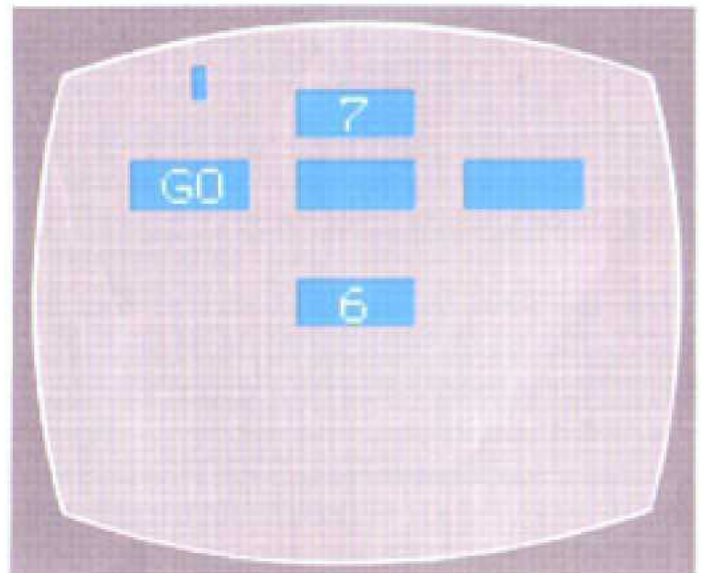

DIFFICULTY SWITCHES

When your difficulty switch is in the b position, the computer will show you the complete sequence of digits to be followed. In the a position, the computer will not show the entire sequence, but only the digit that has been added. If a "miss" is made, the computer will then refresh your memory by showing the entire sequence.

PICTURE ME™ Games 9 and 10

In these one-player games, the computer will display a set of four objects in the center column. While the computer makes a distracting noise, try to memorize the order of the objects from top to bottom. The computer then scrambles the order, moves them to the lefthand column, and gives you twenty seconds to remember their original order.

ATARI® GAME PROGRAM™ INSTRUCTIONS

In Game 9, you have four seconds to memorize the original order of the objects, in Game 10 you have 1½-seconds.

If your guess is incorrect or the time runs out, the computer will show you the correct answer in the lefthand column, before showing the next set of objects.

You get one point for each object placed in the correct position and a bonus score based on the time taken to remember all the objects. Five sets of objects are a game.

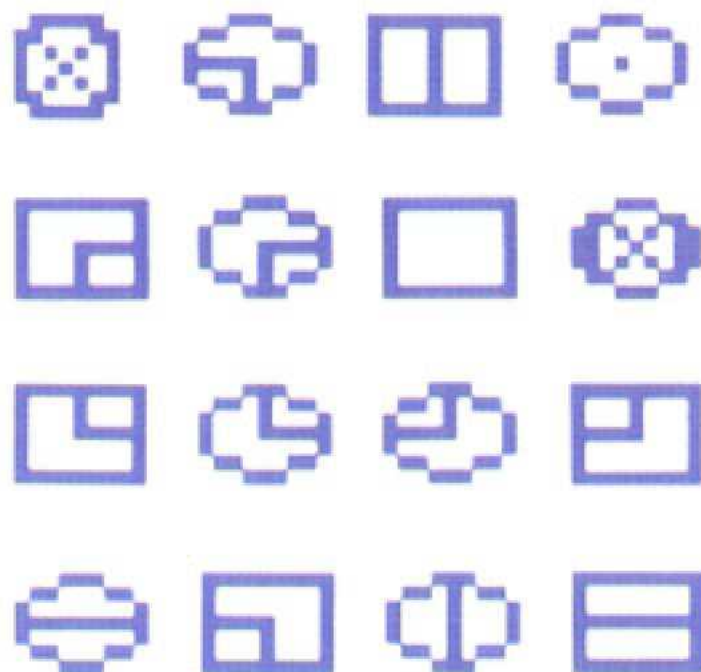

USING THE KEYBOARD CONTROLLER

Each row of numbers on your controller corresponds with one of the boxes on the screen. For example, row one (numbers 1-2-3) corresponds with the top box; row two (numbers 4-5-6) corresponds with the second box, etc. If the first object in the center column was

scrambled to the second box in the left column, push a button in row two of your Keyboard (number 4, 5, or 6). That object will appear in the righthand column in the first box. Continue making selections in this way.

Each object can be selected only once.

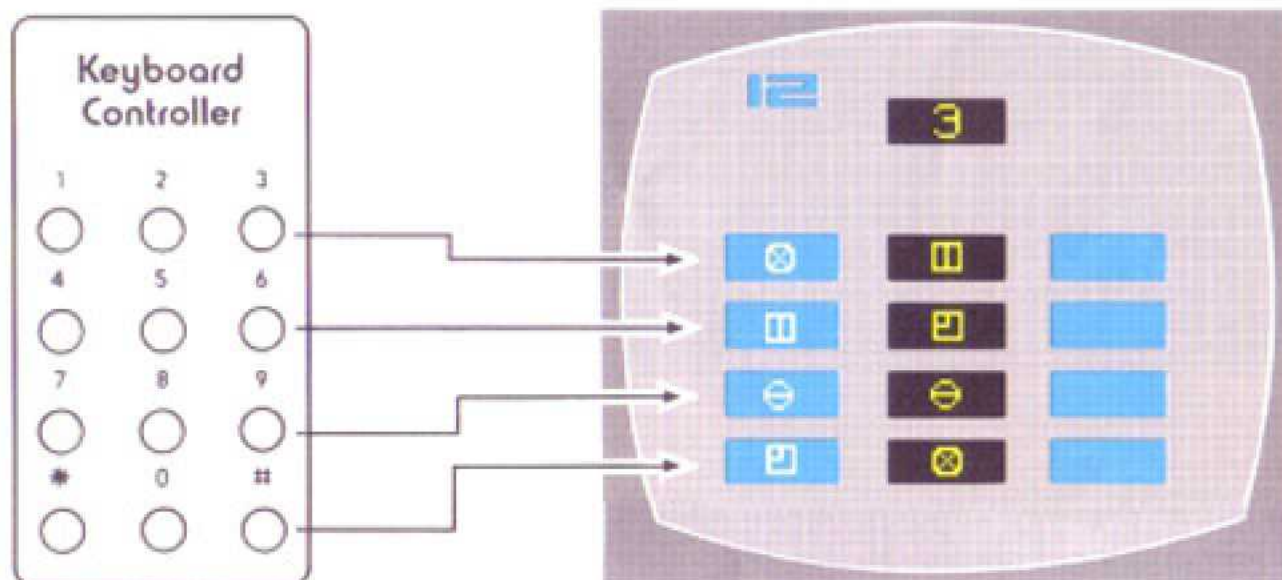

DIFFICULTY SWITCHES

In these games, the left difficulty switch affects the Bonus Scoring. In the **a** position, the Bonus Score added to your correct guesses is one-half the timer value. In the **b** position, the Bonus Score is equal to the timer value. The right Difficulty Switch has no effect.

The best possible score in the **a** position is 45; in **b** the best possible score is 70.

FIND ME™

Games 11 to 14

The computer generates a set of four objects on the screen. All, except one, are identical. Your score is based on the time taken to find the one dissimilar object.

You can continue to enter guesses until the timer runs out. The correct answer will show in the box at the top of the screen. There are five sets of objects per game. In Games 11 and 13 you have 20 seconds to find the dissimilar object; in Games 12 and 14 you have only 5 seconds.

In the one-player games, using the left controller, try to improve your score with each game. In two-player games, each player is competing to find the same dissimilar object and score first.

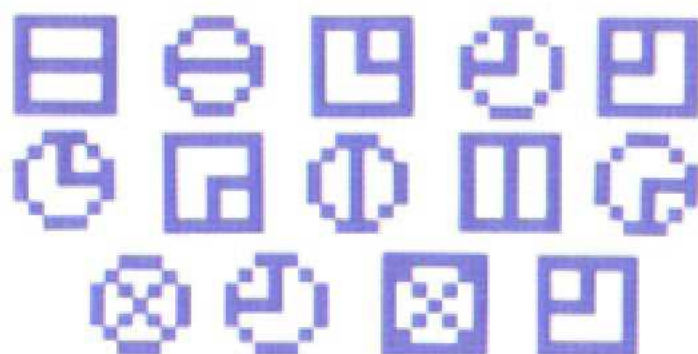

USING THE KEYBOARD CONTROLLER

Each row of numbers on your controller corresponds with one of the boxes on the screen. For example, row one (numbers 1-2-3) corresponds with the top box; row two (numbers 4-5-6) corresponds with the second box, etc. If the dissimilar object is in the fourth box push a button in row four (*-0-#) of your controller. The correct solution to the above diagram is 3.

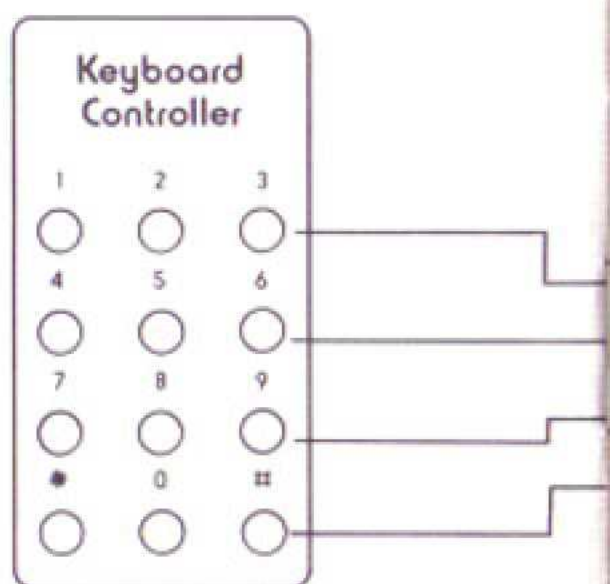

DIFFICULTY SWITCHES

The scoring is affected by the difficulty switches. In the **b** position, the player gets the full value of the timer added to his score. In the **a** position, the player gets one-half the timer value added to his score. Best possible score for position **a** is 25, position **b** is 50.

ADD ME™ Games 15 to 18

A set of digits is generated by the computer. You score by adding the digits and entering the sum before the timer runs out. The correct answer will appear in the box at the top of the screen. There are five sets of digits per game.

With the left controller, continue to practice on the one-player games. In the two-player games, each

player is trying to enter the sum of the same set of digits and score first.

Games 15 and 17 give you twenty seconds to find the sum of four digits. Games 16 and 18 give you five seconds to find the sum of five digits.

USING THE KEYBOARD CONTROLLER

The player using the **a** position on the difficulty switches will receive one-half the timer value added to his score. In the **b** position, the full value of the timer is added to the score. Best possible score for **b** position is 50; best possible score for **a** position is 25.

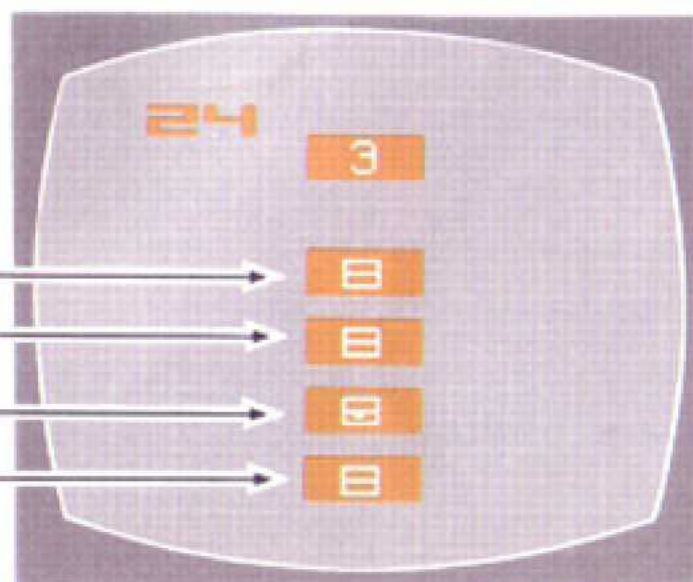

PLAY ME™ Game 19

Your Keyboard Controllers become musical instruments. Each button on the controller generates a different musical note, allowing you to play songs. If both controllers are

used, duets can be played on your Video Computer System game. The difficulty switches have no effect on this game.

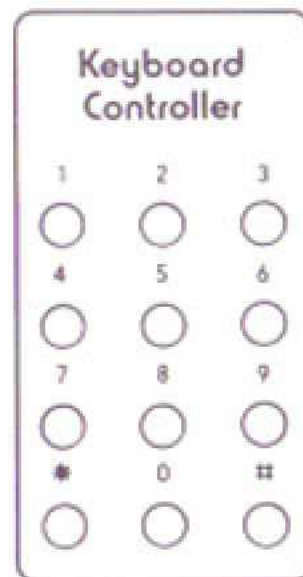
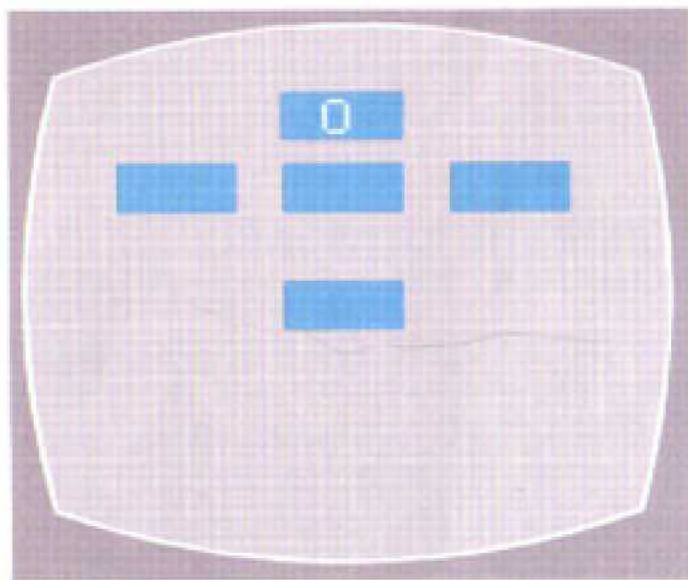

4. PLAY ME SONG BOOK

Press the numbers on your Keyboard Controller in order. Numbers that are underlined should be held for that count.

Happy Birthday

9-9-8-9-6-7-7-7/9-9-8-9-5-6-6/
9-9-2-4-6-7-8/3-3-4-6-5-6-6.

Twinkle Twinkle Little Star

9-9-5-5-4-4-5-5/6-6-7-7-8-8-9-9/
5-5-6-6-7-7-8-8/5-5-6-6-7-7-8-8/
9-9-5-5-4-4-5-5/6-6-7-7-8-8-9-9.

ATARI® GAME PROGRAM™ INSTRUCTIONS

Three Blind Mice

7-7-8-8-9-9-9-9/7-7-8-8-9-9-9-9/
5-5-6-6-7-7-7-7/5-5-6-6-7-7-7-7/
5-2-3-4-3-2-5-5/5-2-3-4-2-3-5-5/
7-7-8-8-9-9-9-9/7-7-8-8-9-9-9-9.

For two people to play duets, the right controller plays the first line, the left controller plays the second line.

Row Your Boat (round song)

9-9-9-9-8-7-7-7/7-8-7-6-5-5-5-5/
 nothing / nothing

2-2-2-2-5-5-5-5/7-7-7-7-9-9-9-9/
9-9-9-9-9-9-9-9/9-9-8-8-7-7-7-7/

5-6-7-8-9-9-9-9/9-9-9-9-9-9-9-9/
7-8-7-6-5-5-5-5/2-2-2-2-5-5-5-5/

9-9-8-8-7-7-7-7/7-8-7-6-5-5-5-5.
7-7-7-7-9-9-9-9/5-6-7-8-9-9-9-9.

5. GAME SELECT MATRIX

	TOUCH ME™				COUNT ME™				PICTURE ME™		
Game Number	1	2	3	4	5	6	7	8	9	10	
Number of Players	1	1	2	2	1	1	2	2	1	1	
Tone	6	9	6	9							
Tone/Digits					6	9	6	9			
Waiting Time (Secs.)									5	3	

	FIND ME™				ADD ME				PLAY ME	
Game Number	11	12	13	14	15	16	17	18	19	
Number of Players	1	1	2	2	1	1	2	2	For 1 or 2 players. Use your controllers to play tunes.	
Slow Time										
Fast Time										
Digits					4	5	4	5		

GAME PROGRAM™ CARTRIDGE LIMITED NINETY DAY WARRANTY

ATARI, INC. ("Atari") warrants to the original consumer purchaser that your ATARI® Game Program cartridge is free from any defects in material or workmanship for a period of ninety days from the date of purchase. If any such defect is discovered within the warranty period, Atari's sole obligation will be to replace the cartridge free of charge on receipt of the cartridge (charges prepaid, if mailed or shipped) with proof of date of purchase at either the retail store where the cartridge was purchased or at one of the ATARI Regional Service Centers listed below:

Atari, Inc.
1312 Crossman Ave.
Sunnyvale, CA 94086

Atari, Inc.
5400 Newport Dr.
Suite 1
Rolling Meadows, IL 60008

Atari, Inc.
43 Belmont Dr.
Somerset, NJ 08873

Atari, Inc.
2109 East Division St.
Arlington, TX 76001

This warranty shall not apply if the cartridge (i) has been misused or shows signs of excessive wear; (ii) has been damaged by being used with any products not supplied by ATARI, or (iii) has been damaged by being serviced or modified by anyone other than an ATARI Regional Service Center.

ANY APPLICABLE IMPLIED WARRANTIES, INCLUDING WARRANTIES OF MERCHANTABILITY AND FITNESS, ARE HEREBY LIMITED TO NINETY DAYS FROM THE DATE OF PURCHASE. CONSEQUENTIAL OR INCIDENTAL DAMAGES RESULTING FROM A BREACH OF ANY APPLICABLE EXPRESS OR IMPLIED WARRANTIES ARE HEREBY EXCLUDED.

Some states do not allow limitations on how long an implied warranty lasts or do not allow the exclusion or limitations of incidental or consequential damages, so the above limitations or exclusions may not apply to you.

This warranty gives you specific legal rights and you may also have other rights which vary from state to state.



A Warner Communications Company 

ATARI, INC., Consumer Division
P.O. Box 427, Sunnyvale, CA 94086