

Sears

TELE-GAMES[®]

FOOTBALL

GAME INSTRUCTIONS

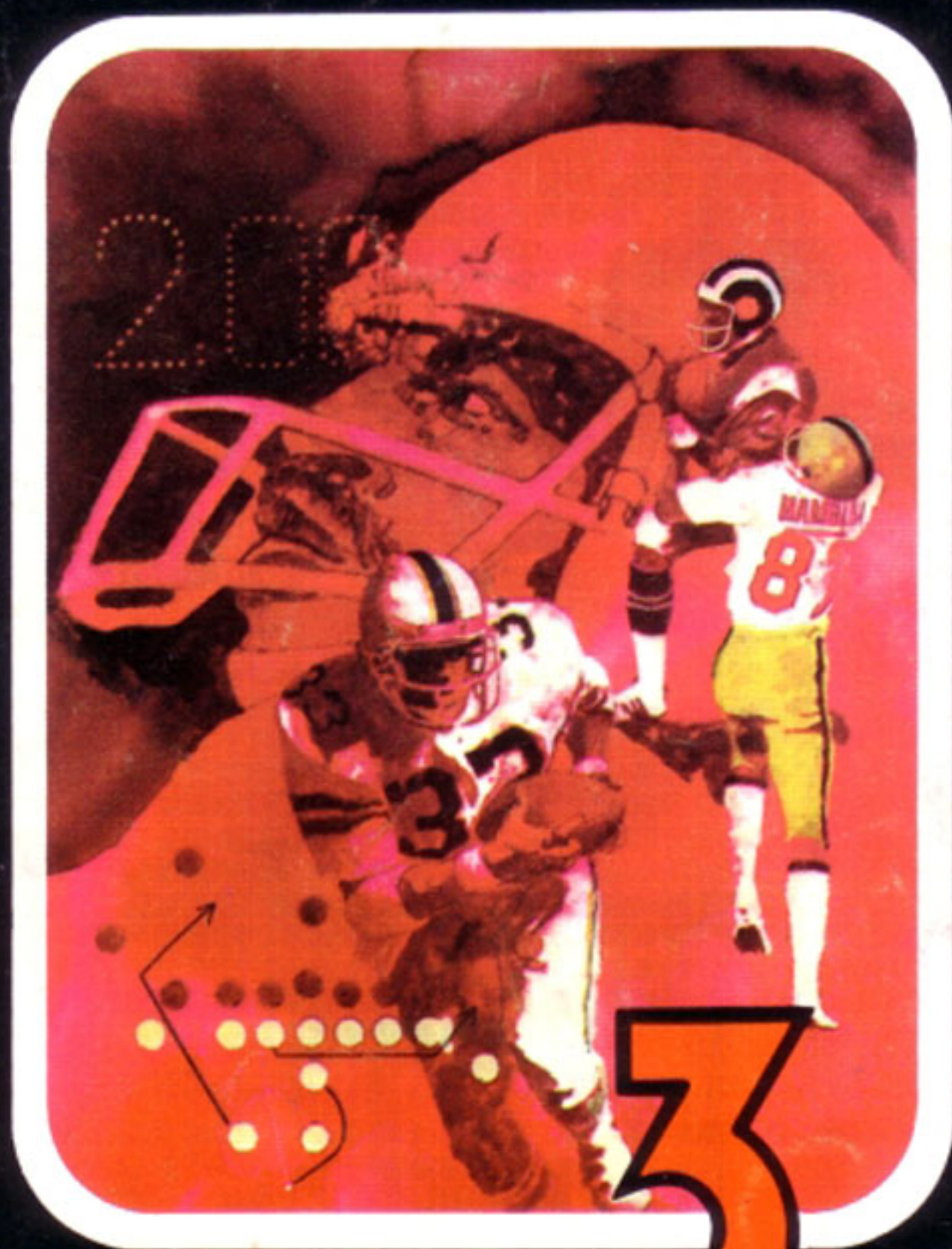

FOR 2 PLAYERS

GAMES

SEARS, ROEBUCK AND CO.

4975114

Use your Joystick Controllers with this Tele-Games® Cartridge. Be sure the controller cables are firmly plugged into the jacks on the rear of your Video Arcade™. Hold the controller with the red button to your upper left towards the television screen. See page 4 of your owner's manual for further details.

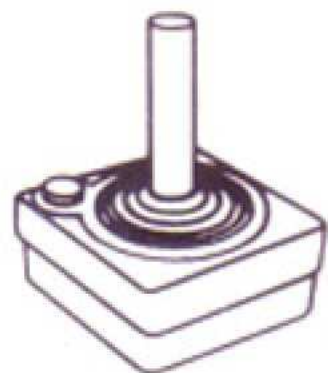

Note: To prolong the life of your console unit and protect the electronic components, the unit should be OFF when inserting or removing a Tele-Games Cartridge.

Note: When playing on a black and white television, place the TV type switch on the console in the color position. Otherwise the white players score will disappear from the screen at game end when the switch is in the black and white (b-w) position.

TO BEGIN PLAY

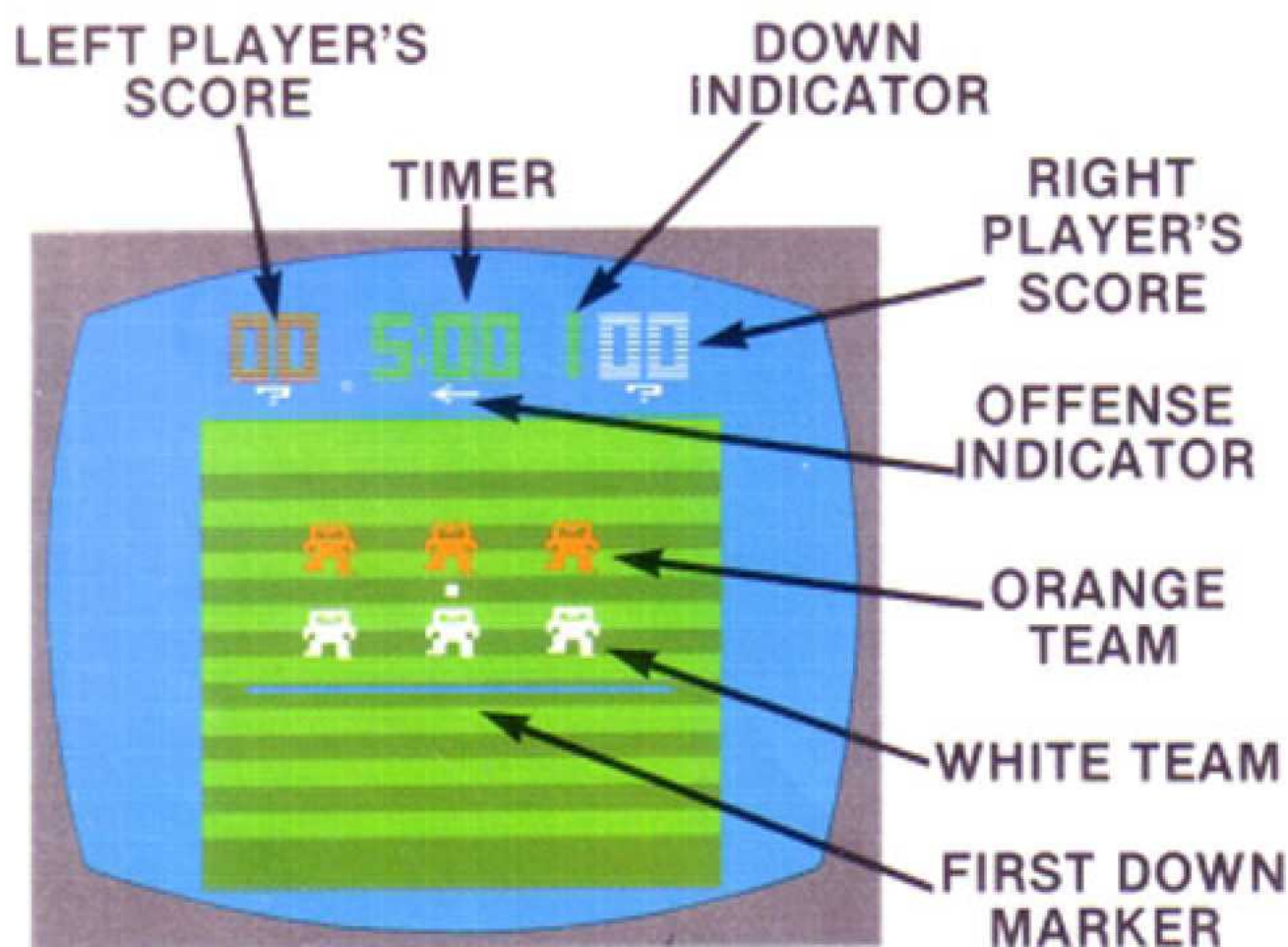

The Timer Clock at the top center of the playfield begins counting down from 5:00. The clock ticks only during play and stops between plays. Depress the game **RESET** switch to start a new game.

The left, or orange, player begins on offense. This is indicated by the small arrow under the Timer Clock. The number at top left is the orange player's score. The number at top right is the white player's score. The number to the left of the white player's score is the Down Indicator.

The question mark (?) beneath each player's score is a reminder to program your play, and will disappear when you do so. The play automatically begins after both players have entered a play formation.

The offensive player has four "downs" or attempts to get the ball over the First Down Marker or the line shown on the screen. If the offense moves the ball over the First Down Marker, he receives another four downs. If the player scores, his opponent receives the ball and becomes the offensive team.

To stop your opponent from getting a first down or scoring, you must "tackle" him by stopping his forward motion. Do this by maneuvering one of your players into his path and touching him.

USING THE CONTROLLER

There are five offensive and five defensive formations. Use your joystick to program the formation you wish to use, (see diagrams on back pages). For a punt formation, push the red controller button.

After the play begins, each player (in games 1 and 2) can control his men with the Joystick. (Diagram refers to movement as you see it on your television screen). The offensive player controls only the ball carrier and can pass (or punt from the punt formation) by pressing the red controller button.

The defensive player controls his lineman with the Joystick. When the red controller button is pressed, the Joystick will control the defensive back.

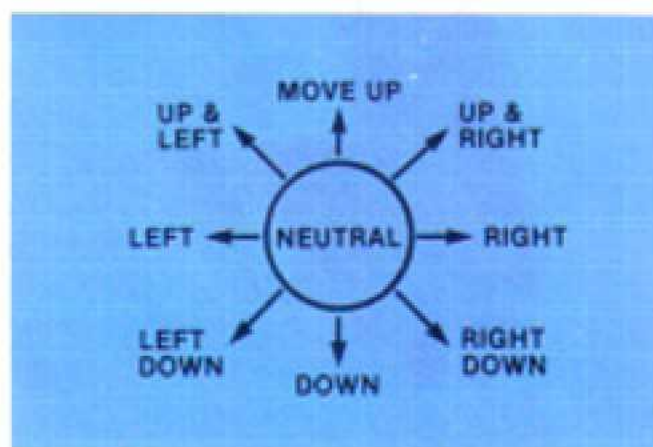

All offensive plays can be pass plays, except when a "punt" play is set. Any player (including your opponent) is an eligible receiver. All passes must be made behind the "line of scrimmage" or the line on which the play started.

To punt, push the red controller button to program the "punt formation." After the play starts, push the red button

again and your Quarterback will kick the ball. On a punt play only the defensive back can catch and return the ball. If the ball is not caught, the computer will randomly select the yardage or length of your kick.

In games 1 and 2, the path of the ball on a pass or punt can be "steered" after it leaves the Quarterback by using the Joystick. You can steer the ball left or right only.

SCORING

The offensive team scores a "touchdown" (seven points) by moving the ball past the opponent's goal line. The defensive team can score a "safety" (two points) by tackling the opponent behind his goal line. In addition, the defensive team gets the ball.

HANDICAP (Skill Switches)

When placed in the **EXPERT** position your players cannot move from side to side as quickly as in the **NOVICE** position. This will give the more experienced player a handicap.

GAME DESCRIPTIONS

Game 1 After programming your play, use the Joystick to control your players. The offensive player controls only the ball carrier and the flight of the pass or punt. The defensive player controls his lineman or, by holding the red controller button down, the defensive back.

The players will randomly follow the play as programmed when not controlled by your joystick.

Game 2 In this game, when your players are not controlled by the Joystick, they will follow the play exactly as programmed. Use more strategy and try to outguess your opponent's plays.

Game 3 Program in your offensive and defensive plays and watch the computer run them out. Neither player can control the players movements, but the offense can pass or punt the ball by pushing the red controller button.

OFFENSIVE PLAYS

- 1 SPLIT LEFT
- 2 TIGHT RIGHT
- 3 SPLIT RIGHT
- 4 TIGHT LEFT
- 5 PUNT

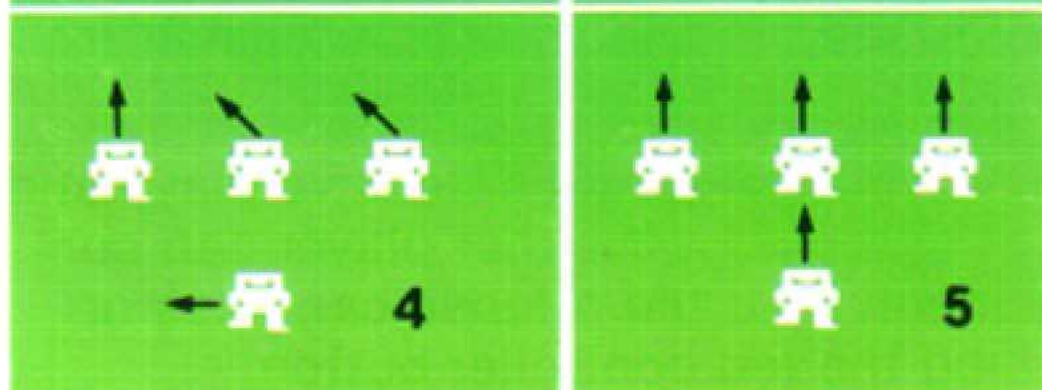
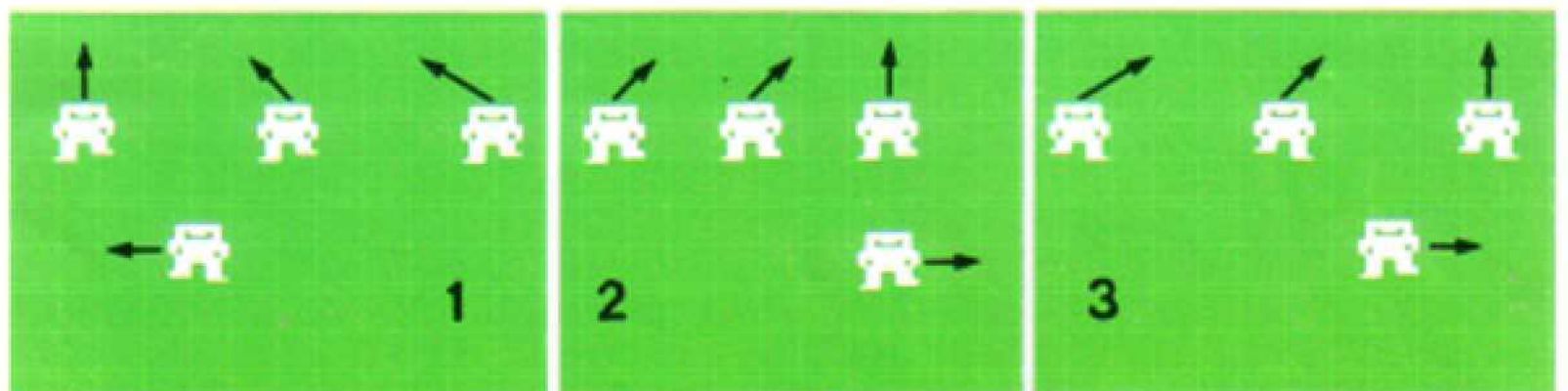
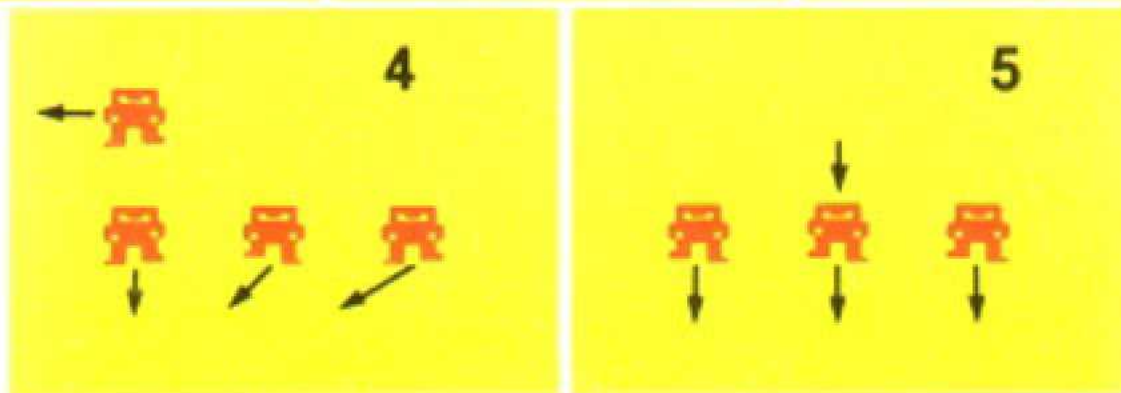
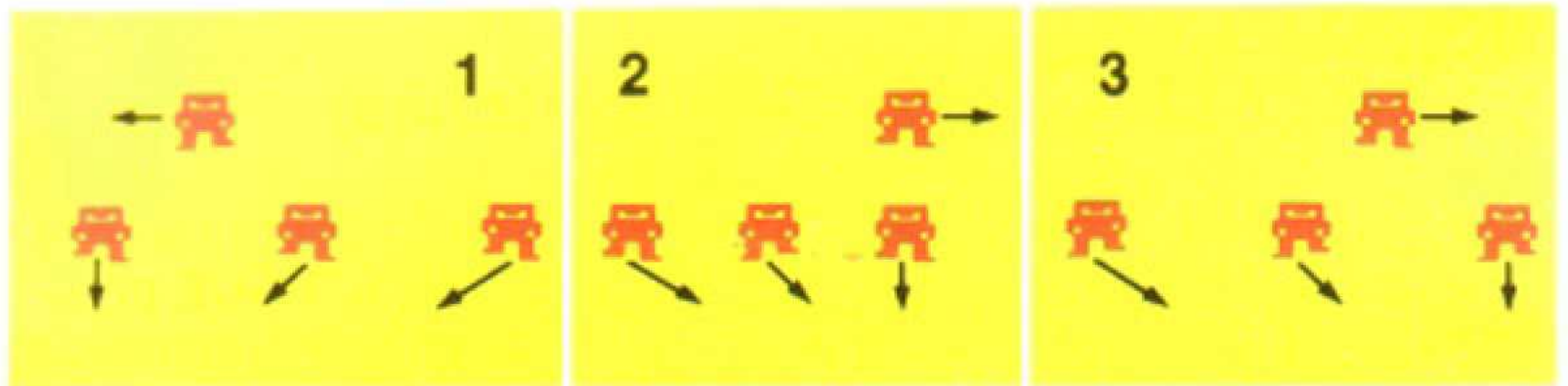
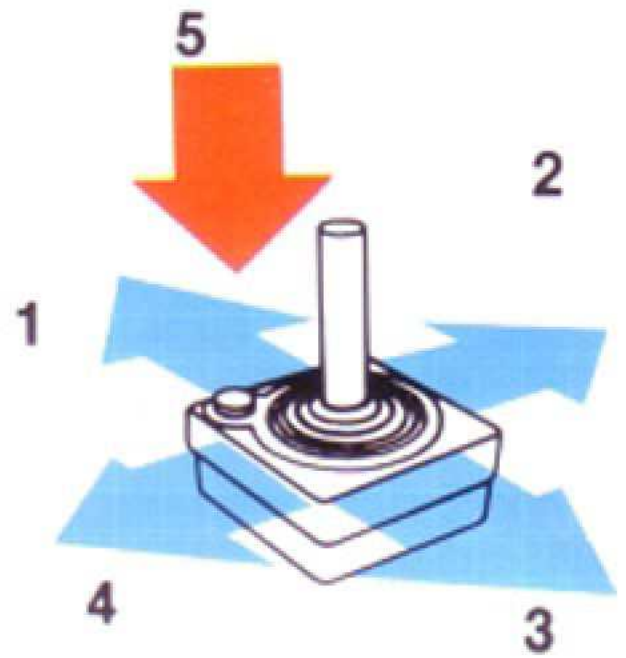

Right and left refers to how the teams are viewed on the playfield.

DEFENSIVE PLAYS

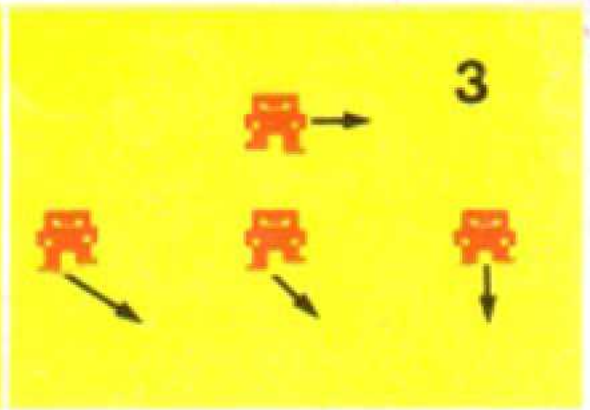
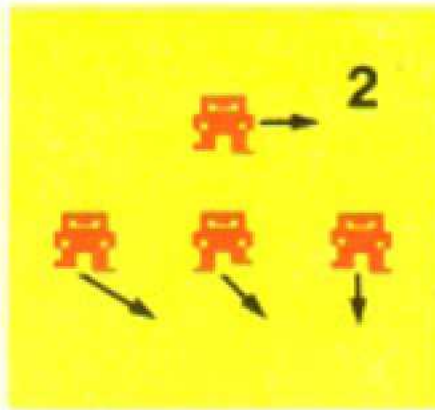
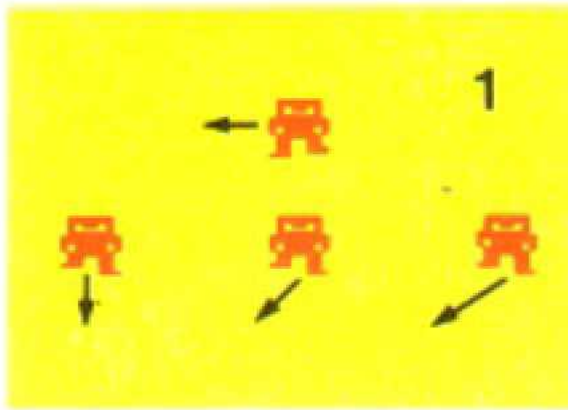

Right and left refers to how the teams are viewed on the playfield.

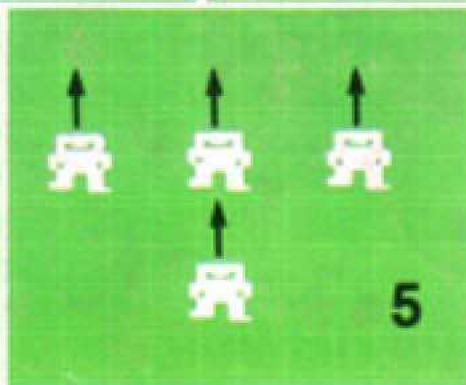
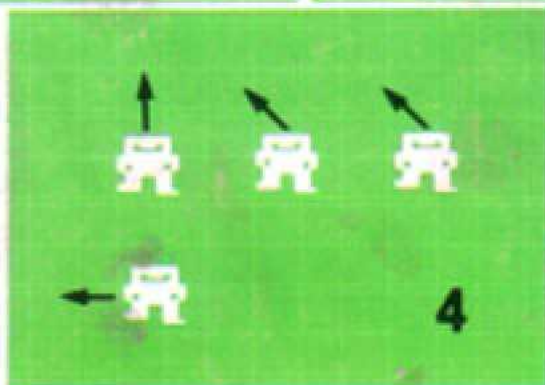
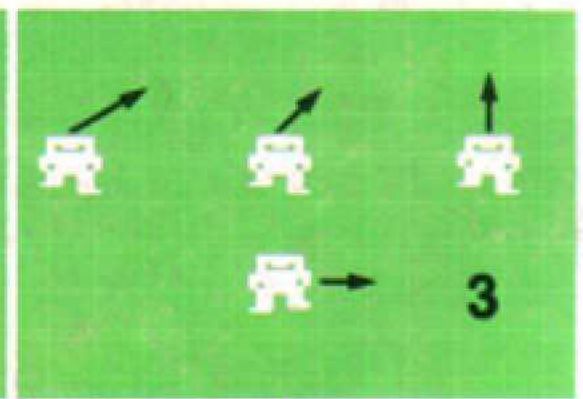
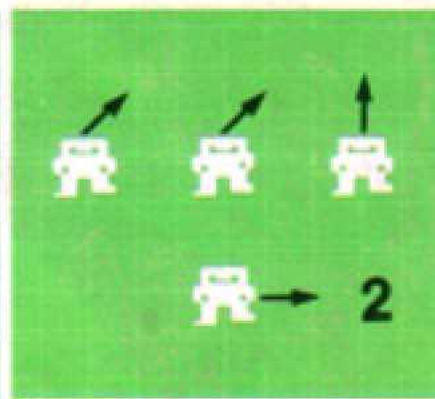
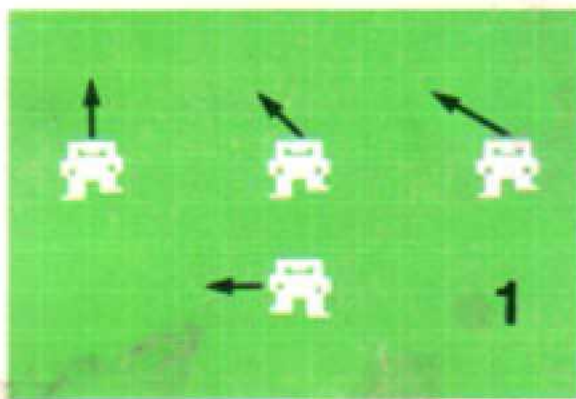
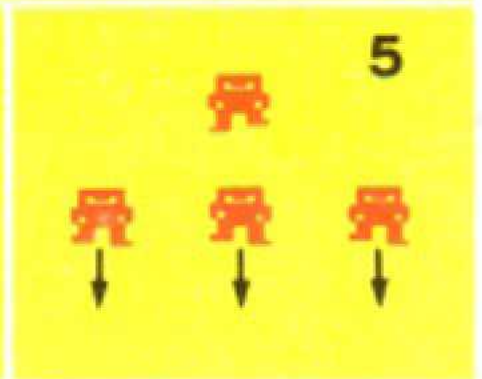
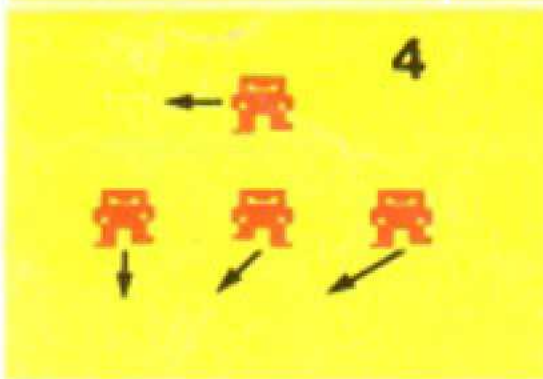

- 1 WIDE LEFT
- 2 TIGHT RIGHT
- 3 WIDE RIGHT
- 4 TIGHT LEFT
- 5 DEEP

