

# INTERNATIONAL SOCCER™

## I N S T R U C T I O N S (For 2 players)

The object of the game is to score more goals than your opponent in two simulated 45-minute periods. A goal is scored by kicking the ball into your opponent's net. Each player has a 4-man team. You control one man on your team. Computer controls the other 3 and moves them to simulate a full 11-man team. You see 1/3 of the soccer field at any given time during game play. Screen moves (scrolls) to follow game play.

**For Your Atari\* 2600 Game System**

\* ATARI is a trademark of ATARI, INC.

# THE GAME

There are 2 teams — YELLOW and BLUE. For the first half, Yellow defends the TOP goal, Blue defends the bottom goal. Teams switch ends for the second half.

A KICK-OFF begins each half of the game and starts play after a goal is scored. Yellow team kicks off the first half. Blue team kicks off the second half. Team scored AGAINST kicks off after a goal.

To kick off, move the man in the kick-off circle. Until this happens, player on defense has no control over his team. Once the man in the kick-off circle is moved, both teams may try for possession of the ball. To get possession, move your man so he touches the ball.

WHEN YOU HAVE THE BALL, move it toward your opponent's goal by dribbling or passing. Shoot into the net.

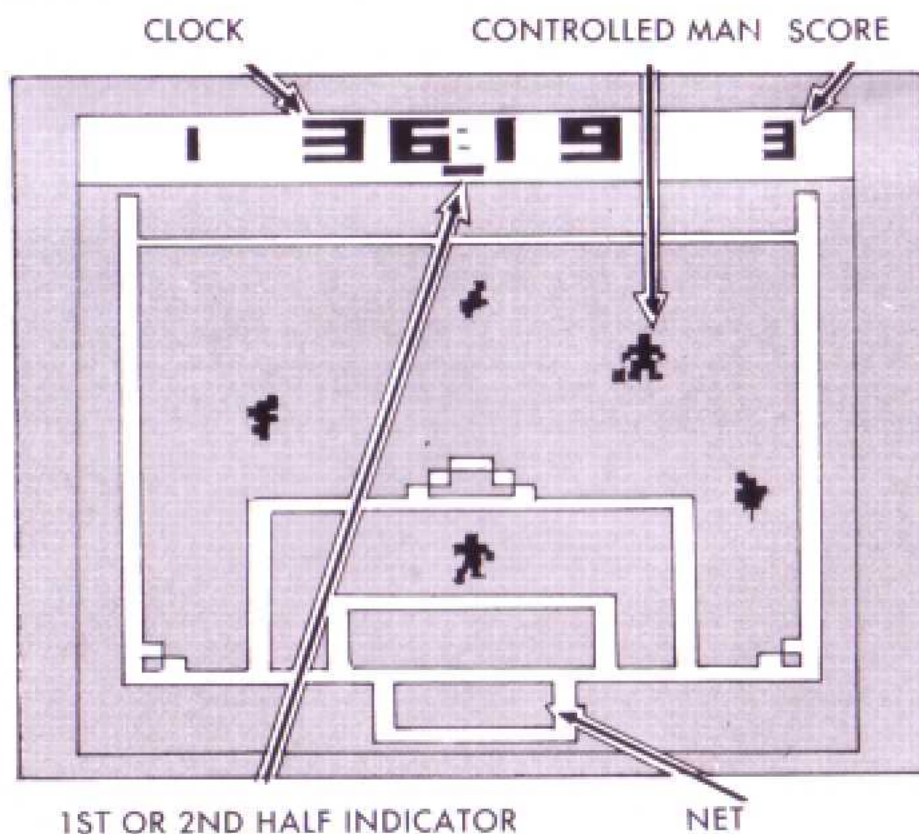

When a goal is scored, the CLOCK STOPS and the ball returns to the kick-off circle. Teams take up kick-off positions. CLOCK STARTS again at kick-off.

WHEN PLAYING DEFENSE, try to steal or intercept the ball. Your man can outrun the ball carrier. If your opponent gets close to your goal, move your controlled man to protect it. Computer-controlled men might not stop the ball.

No offsides, goalies, throw-ins, corner kicks, goal kicks, penalties, time-outs or overtime.

## CONTROLLING YOUR MAN

Use the LEFT joystick controller for the YELLOW team. Use the RIGHT Joystick controller for the BLUE team.

You control ONE man on your team. When you have the ball, your controlled man is the ball carrier. When playing defense, your controlled man does not change.

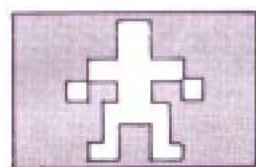

Controlled man when stopped.

All members of a team are the same color, but the controlled man has a different shape when not moving, so you can tell him apart.

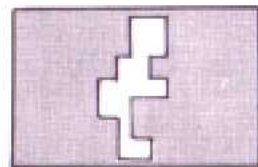

Computer-controlled man when stopped.

TO MOVE YOUR CONTROLLED MAN, push the joystick in any of 8 directions. If your man has the ball, moving him will DRIBBLE THE BALL. (Remember that dribbling slows your man down.)

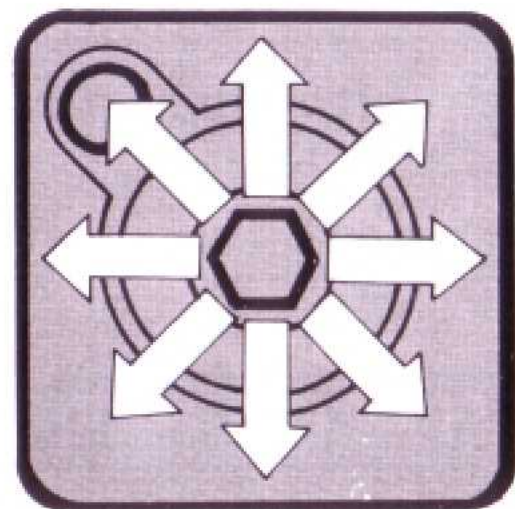

TO PASS OR KICK THE BALL, press the RED BUTTON. The ball will travel in the last direction in which the joystick was pushed.

NOTE: THE DIFFICULTY SWITCHES ARE NOT USED IN THIS GAME. Game speed and level of difficulty are the same, regardless of Difficulty Switch position.

# PLAYING DETAILS

## TO STEAL THE BALL:

- Overrun or intercept your opponent, so your man touches the ball. Move quickly away or opponent's man will steal it back.
- Intercept a pass.

If one of your computer-controlled men gets the ball, he becomes your new controlled man.

## PASSING:

- Ball carrier can pass the ball while moving or standing still.
- When the ball is passed, computer-controlled men on both teams will move horizontally to intercept the pass.

If the ball carrier gets too close to a boundary and shoots directly at it, the ball will bounce off the boundary and pass through the ball carrier on its return. This does not happen when the ball is kicked into the net, regardless of the distance from which it is kicked.

## SCROLLING:

As the ball moves downfield, the screen will move — or SCROLL — in the opposite direction, so the ball is never off screen. The screen will stop scrolling when either goal comes fully in view.

MAN MOVES OFF  
SCREEN HERE.



MAN WILL APPEAR  
HERE. PASS TO  
THIS POINT.

If a man goes off the top or bottom of the screen during scrolling he will reappear at the other end of the screen, in the same relative place. This feature is useful for:

- **PASSING.** If a team member is moving off screen, pass the ball to the point where he will reappear.

MOVE OFF SCREEN  
AT THIS POINT.

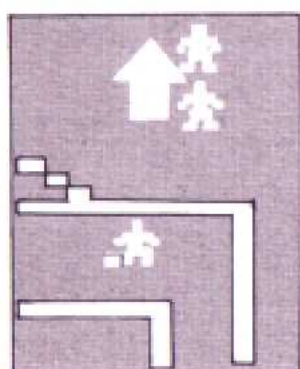

OPPONENT'S CONTROLLED MAN (WITH BALL)

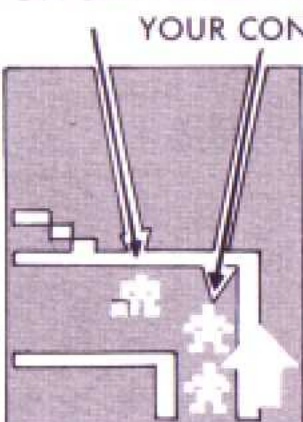



• GOAL DEFENSE. Your controlled man may be too far from your goal to reach it in time to defend it. Move him in the opposite direction, until he disappears off the end of the screen opposite your goal. He will reappear at the goal.

YOUR MAN  
REAPPEARS HERE.

## WINNING TIPS

 LEARN TO PASS EFFECTIVELY. Watch how team members move off and on screen, as the screen scrolls. Make the scrolling effect work to your advantage with off-screen passing.

 WATCH YOUR AIM when you pass or shoot. Wild shots and passes may be intercepted by your opponent.

 STEAL THE BALL. Remember that the man with the ball is slowed down by dribbling.

 WHEN PLAYING DEFENSE, if your controlled man falls too far behind the man with the ball, let him drop back all the way off screen. He will reappear in front of the man with the ball.

 Remember that the BEST DEFENSE IS A GOOD OFFENSE. Get possession of the ball and keep it until you score!

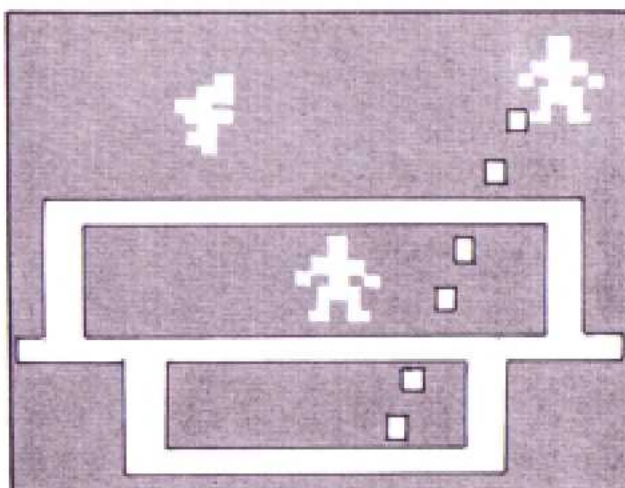

SCORE!

IMPORTANT: BE SURE TO TURN YOUR GAME UNIT OFF WHEN NOT IN USE.

# 90 DAY LIMITED WARRANTY

TELEGAMES warrants to the original consumer purchaser of any cartridge or cassette it manufactures that the product will be free of defects in material or workmanship for 90 days from the date of purchase. If defective, return the product along with proof of the date-of-purchase to either your local dealer or, postage prepaid, to:

TELEGAMES USA  
BOX 901  
LANCASTER, TX75146

TELEGAMES UK  
KILBY BRIDGE, WIGSTON  
LEICESTER LE81TE

for repair or replacement. This warranty gives you specific legal rights, and you may also have other rights which vary from state to state. This warranty does not cover damage resulting from accident, misuse or abuse.

THIS PRODUCT IS MANUFACTURED UNDER WORLDWIDE LICENSE BY

**TELEGAMES**

NEW  
FOR YOUR  
ATARI 2600  
AND COMPATIBLE SYSTEMS

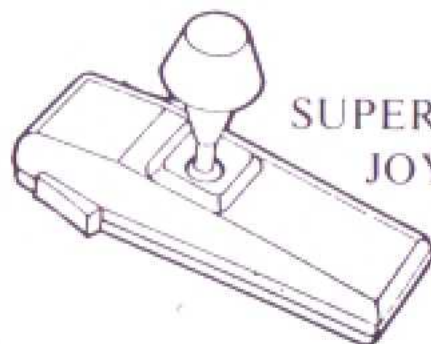

SUPER DE-LUXE  
JOYSTICK

SEE YOUR DEALER OR  
SEND FOR FREE LIST TO:

**TELEGAMES**