

ROBOTWAR

2684



CHAMP

GAMES

ROBOTWAR

2684

INSPIRED BY THEIR NEVER ENDING QUEST FOR PROGRESS, IN 2684 MAN PERFECTS THE ROBOTRONS: A ROBOT SPECIES SO ADVANCED THAT MAN IS INFERIOR TO HIS OWN CREATION.

GUIDED BY THEIR INFALLIBLE LOGIC, THE ROBOTRONS CONCLUDE: **THE HUMAN RACE IS INEFFICIENT AND THEREFORE MUST BE DESTROYED**; WAR IS DECLARED.

YOU ARE THE LAST HOPE OF MANKIND. DUE TO A GENETIC ENGINEERING ERROR, YOU POSSESS SUPERHUMAN POWERS. YOUR MISSION IS TO STOP THE ROBOTRONS AND SAVE THE LAST HUMAN FAMILY.

GOOD LUCK!

In RobotWar: 2684, the object is to save the last human family by rescuing the humans and destroying the Robotron enemies to advance to the next wave.



Mutant



Mommy



Daddy



Mikey



In each wave, your mutant player starts out in the middle of the arena, while the Robotrons and humans spawn around you.

Use the Joystick controller to move your player to avoid the enemies and pick up the humans.



Use a second Joystick or the fire button to shoot your laser gun to destroy the enemies and advance to the next wave.

GAME SETTINGS

There are three skill levels in RobotWar: 2684: **NOVICE**, **STANDARD** and **ADVANCED**.

On the title screen, move the joystick LEFT and RIGHT to select the desired skill level.

NOTE: The color of your player's helmet matches the color of the skill level.



	NOVICE	STANDARD	ADVANCED
Lives			
Enemies at start	50%	75%	100%
Enemy spawn, fire and movement rate			

Once you start a new game, you will be prompted to select the starting wave (1, 11, 21 or 31).

There are 256 waves in RobotWar: 2684.

Select a higher starting wave for a more challenging game.

Move the joystick in the directions shown to increase or decrease the starting wave, then press the FIRE button to start the game.



GAME MODES

RobotWar: 2684 supports one player, two player (alternating turns) and two player co-operative game modes. Press SELECT on the title screen to cycle through the game options and press the FIRE button or RESET to start a new game.



1 PLAYER



In a one player game, the objective is to amass the highest score possible by destroying Robotrons and rescuing humans.

This mode is available for all control configurations (see pages 5 and 6).

2 PLAYER

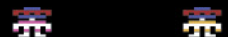

In a two player game, each player takes turns controlling their own mutant, attempting to obtain a better score than the other player.

This mode is available for all control configurations (see pages 5 and 6). If only one controller is connected, then both players will take turns with that controller.

2 PLAYER CO-OP



In a two player co-op game, each player controls a mutant on the screen at the same time. The players work together to collect the humans and clear each wave of the Robotron enemy forces to contribute to a shared score

with a shared pool of reserve lives.

Additionally, in a co-op game, when a player collides with a Robotron or is hit by enemy fire, they are temporarily stunned and will start flashing on the screen. The other player then has a limited amount of time to revive that player by touching them. If that time runs out, the stunned player will explode!

The time available for rescue depends on the chosen skill level.

NOVICE	STANDARD	ADVANCED
12 seconds	9 seconds	6 seconds

If the player attempting the rescue also meets their demise, a life from the shared reserves is lost.

A player can only be revived once per life on the current wave. If a player has been revived and collides with an enemy, they are removed for the remainder of that life. Both players will return to the battle when a new life is used or at the start of the next wave.

This mode is only available with two or more controllers connected.

left difficulty



SINGLE STICK CONTROL METHODS

right difficulty



Left difficulty switch sets fire options for PLAYER 1.

Right difficulty switch sets fire options for PLAYER 2.



PLAYER 1 uses the left controller port while PLAYER 2 uses the right.

manual fire

difficulty

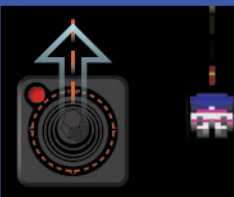

Press **FIRE button** to fire in direction of movement.

Hold **FIRE button** to lock firing direction.

Joystick Controller

You can fire in multiple directions when stationary by releasing the joystick and FIRE button, then holding down the FIRE button while rotating the joystick.

auto fire difficulty

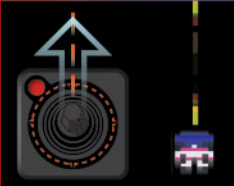

Automatic firing locked to initial movement direction.

Press **FIRE button** to change firing direction to current movement direction.

Joystick Controller

You can fire in multiple directions when stationary by releasing the joystick and holding the FIRE button, then rotating the joystick.

manual fire

difficulty



Press **Button B** to fire.

Button C fires in opposite direction.

SEGA Genesis / Mega Drive Pad

You can fire in multiple directions when stationary by releasing the D-pad and buttons, then holding down a button (B to fire forwards, C for reverse) and rotating the D-pad.

auto fire difficulty



Button B rotates fire counterclockwise.
Button C rotates fire clockwise.

SEGA Genesis / Mega Drive Pad

You can fire in multiple directions when stationary by releasing the D-pad, then holding down Buttons B and C and rotating the D-pad.

TWIN STICK CONTROL METHOD



PLAYER 1 uses Joysticks plugged into both ports.

left difficulty



Left stick to move. Right stick to fire.



Joystick Controllers

The FIRE buttons are not used in this mode.

IN-GAME CONTROLS

game select



Press **SELECT** during a game to return to the TITLE screen.

game reset



Press **RESET** to restart the game with the current options.

tv type



Flip the **Color/B-W** switch (2600) or press **PAUSE** (7800) to pause or resume a game. FIRE button will also resume.

PAUSE

QUADTARI

By plugging in a QuadTari Interface, it is possible for both players to use the Twin Stick control method.

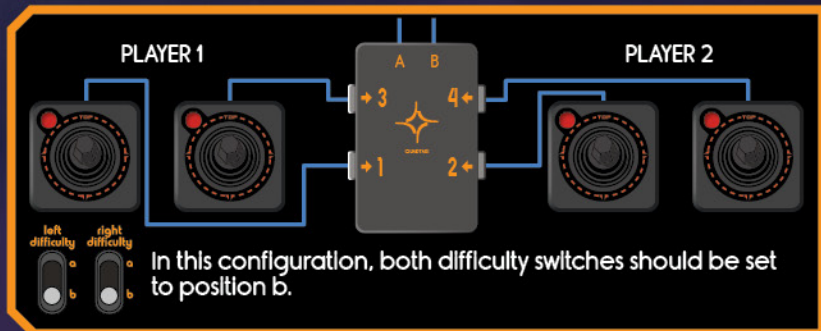

It is also possible for PLAYER 1 to play Twin Stick and PLAYER 2 to play Single Stick by only plugging cable A of the QuadTari into the Left controller port, freeing up the Right controller port for a single joystick. Left difficulty must be set to b.

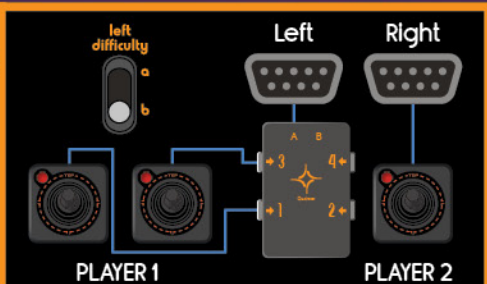

Using this setup, it is also possible for both players to play Single Stick (using the controllers in ports 1 and 3), leaving port 2 or the Right controller port free for an AtariVox or SaveKey (see page 12). Both auto and manual fire modes are available.

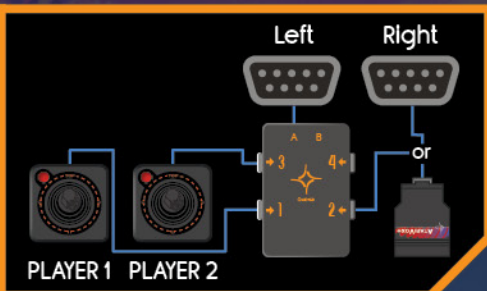

THE ENEMIES

GRUNTS

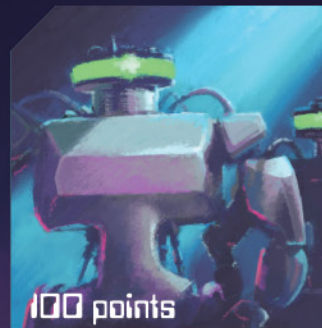

100 points

The force of Ground Roving Unit Network Terminator (or GRUNT) Robotrons seek to destroy you. They are the least sophisticated of the robots and predictably walk in a clunky pattern, speeding up as the wave progresses. They do not possess any weapons, but will kill on contact.

HULKS

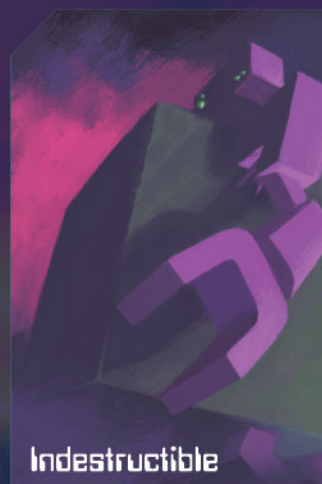

Indestructible

The Hulk Robotrons seek out and eliminate the last human family. They cannot be destroyed by your laser gun, but you can thwart their advancement or divert them from their task by shooting at their protective armor. **WARNING:** Your Intel has learned that the Robotrons have been working on a faster Hulk Robotron (codename 'Turbo Hulk') that can move twice as fast as its predecessor, although it is rumored that this extra speed has been obtained at the expense of a lighter armor shield.

SPHEREOIDS



1000 points

The pulsating sphereoids move around the arena in a quick dart-like pattern, slowing down only to spawn Enforcers. Shoot them quickly, or you will soon be overrun!



ENFORCERS



Enforcers are spawned from Spheroids. They track you in a circular pattern and shoot deadly Sparks.

150 points

 Sparks 25 points



QUARKS



Quarks are similar to Spheroids in that they start a wave roaming around in quick, unpredictable patterns. If they are allowed to survive long enough, they will manufacture Tank Robotrons.

1000 points



TANKS



Tank Robotrons move in a slow, erratic pattern while tracking your player. Shoot them quickly before they have time to launch rebounding Shells that are almost impossible to avoid!

200 points

 Shells 50 points

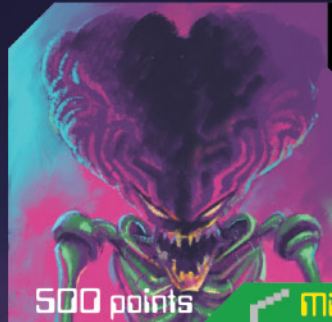

BRAINS



The Brains are the most clever and dangerous of the Robotrons. They roam the arena searching for humans to convert into enemy Progs. They will also periodically launch Cruise Missiles that will mercilessly seek you out.

500 points

 Missiles 25 points

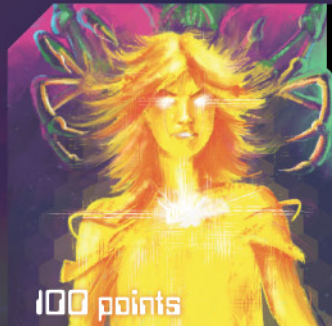

PROGS



Progs are created by Brains when they capture a human. The progs move very fast in a straight pattern and are deadly to the touch.

100 points



ELECTRODES



Electrodes are placed randomly around the arena to block the path of your player. Colliding with an electrode means instant death. Shoot them to clear a path and avoid being cornered by the other Robotrons.

ADDITIONAL SCORING

You also receive points for rescuing the last human family. The amount of points increases for saving multiple family members.

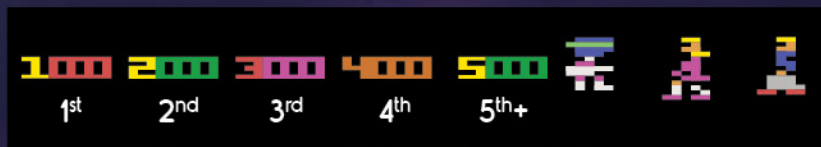

Point values for family members reset at the start of a new wave or after a life is lost.

An additional reserve life is awarded every 25,000 points (every 50,000 points in co-op play).

HIGH SCORES

The game ends when the last life is lost and all reserves have been depleted for both players.

If a high score is achieved at the end of a player's game, the high score entry screen is displayed and the player will have an opportunity to enter up to three initials:

Joystick UP/DOWN to cycle through the available characters.

Joystick LEFT/RIGHT to select the initial to change.



Press the FIRE button to accept the current initial and move to the next. Press the FIRE button on the third initial to complete the entry and view the list of HIGH SCORES.

The current initials are used after one minute with no user input.

The top five scores for each skill level are displayed, including the highest wave reached and the player's initials. If the game was started on a wave other than the first wave, a + is added before the wave number. Additionally, if the game played was a co-op game, a + is added before the initials.



To reset the high scores for the current skill level, switch the Color/B-W switch (2600 models) or press the PAUSE button (7800). The message "RESET SCORES?" will be displayed. Press the BUTTON to complete the reset or move the joystick to cancel.

High scores are reset when the game is powered off unless an AtariVox or SaveKey is connected.

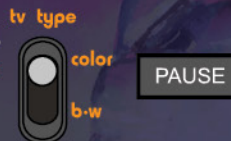

With an optional AtariVox or SaveKey connected to the Right controller port (or port 2 of a QuadTari), it is possible to save your high scores.

Up to five high scores are saved for each skill level. The current skill level, game mode and player options are also saved.

To reset all scores and settings for all skill levels, press and hold down RESET while powering on the game.

NOTE: because the Right controller port is occupied, a QuadTari would be required to enable any multi-stick gameplay modes.



AtariVox



SaveKey

TIPS AND TRICKS

- Be sure to save as many humans as you can before shooting the last enemy in a wave, since you are awarded the most points for this deed.
- Shoot Sphereolds and Quarks as soon as possible before they are able to spawn and manufacture enforcers and tanks.
- Sphereolds will retreat to a corner before attack; this is your chance to blast them before they can gather their bearings!
- Blast Hulks with your laser gun to push them backwards or alter their path to save a human for a future rescue.
- On some Brain levels (5, 25, 45, etc.), there is one Milkey humanoid. The Brains will not pursue any other humans as long as Milkey is kept alive, so protect him as long as you can!
- If you shoot a Brain while they are in the middle of programming a human, that human will be set free (NOVICE and STANDARD skill only). Be careful to not shoot the human, though!
- In later levels, it is easy to get surrounded by the GRUNTS as they grow in number. Plan out your escape route at the beginning of the wave while the enemies are spawning.
- If Enforcers are spawned, avoid the deadly sparks that they launch towards your mutant. The sparks tend to travel along the borders so avoid them if possible.
- If Tank Robotrons are manufactured, shoot them quickly before they are able to fire a volley of the bouncing Tank Shells.

GAME CREDITS

CODING AND DESIGN
JOHN W. CHAMPEAU

GRAPHICS
NATHAN STRUM

SOUND
DAVID BROWN

ADDITIONAL SOUND
JOHN W. CHAMPEAU

ILLUSTRATION AND MANUAL DESIGN
DAVID EXTON

GAME TESTING
JOE CHAMPEAU
STEVE AND CHRIS M. RAMIREZ

PUBLISHED BY CHAMP GAMES
WWW.CHAMP.GAMES

© 2021, 2023 CHAMP GAMES LLC

