

ATARI

# SECRET QUEST

TM



## KEY

- X: START
- T: TELEPORTER
- C: CODE
- D: SELF-DESTRUCT
- S: STAIRS
- K: SONIC KEY
- ? : SONIC DOOR
- E: ENERGY POD
- O: OXYGEN BOTTLE
- G: LASER GATES
- H: ENERGY SHARD
- B: SONIC BLASTER
- P: PARTICLE BEAM
- SS: INITIALS

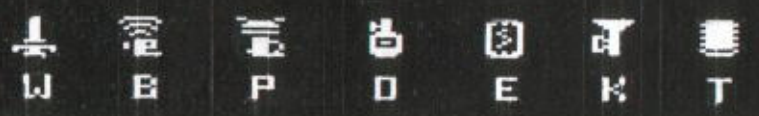

STATION 1

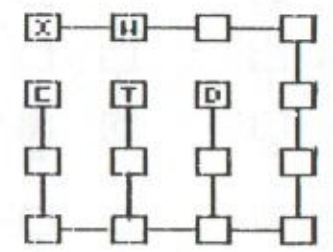

STATION 2

CODE

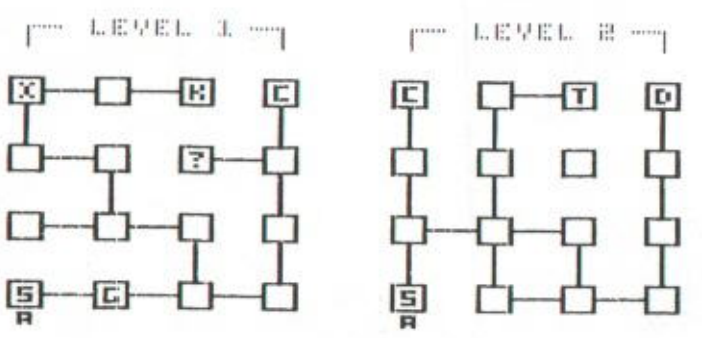

STATION 3

CODE

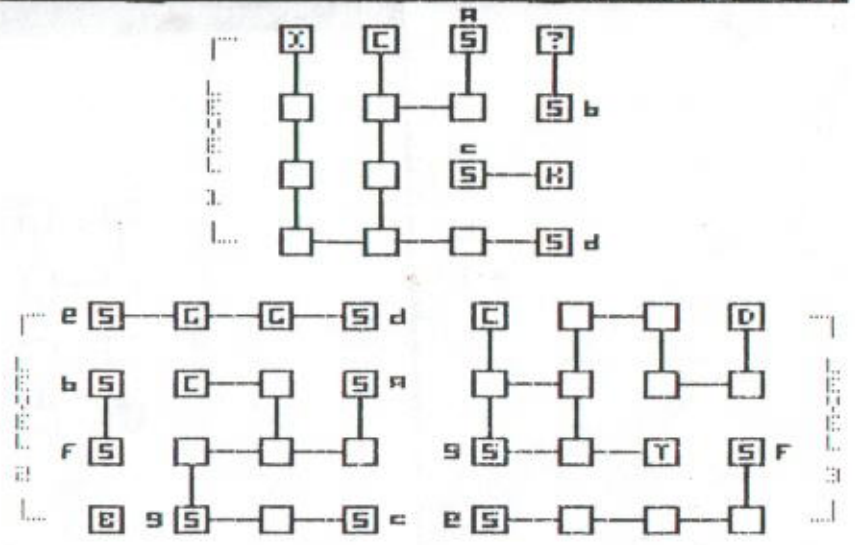

STATION I

II

CODE

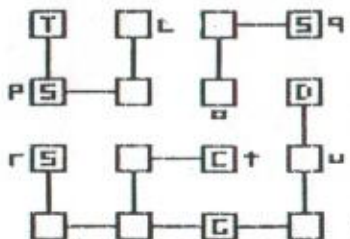
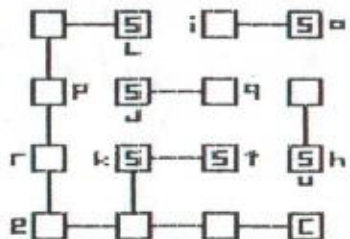
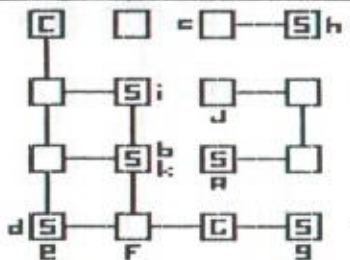
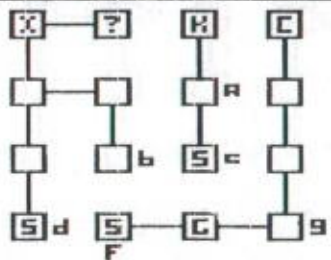

STATION I

III

CODE

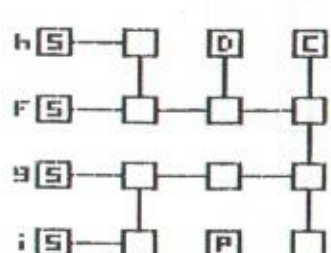
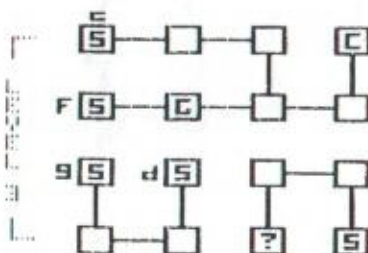
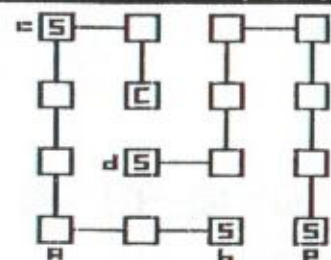
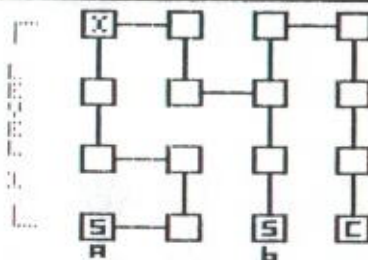

STATION I

IV

CODE

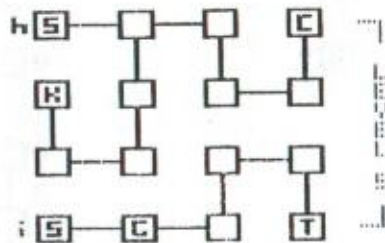

STAFF JONI

IS

CODE

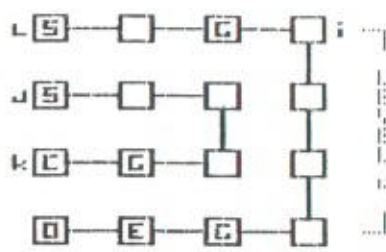
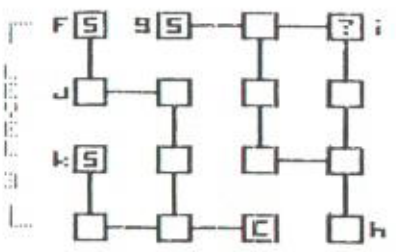
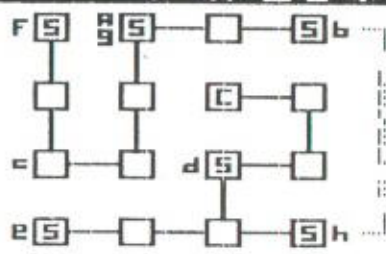
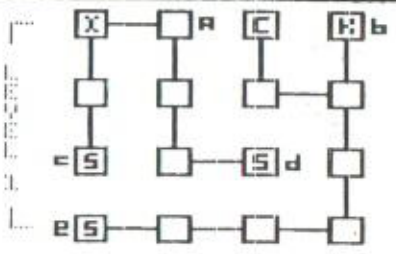

STAFF JONI

IS

CODE

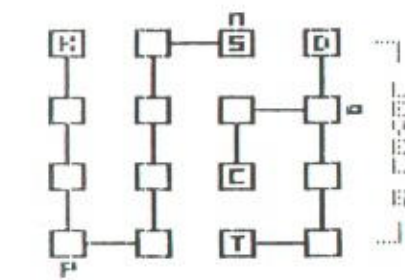
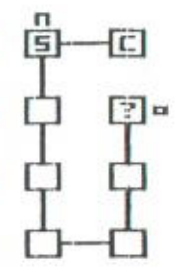
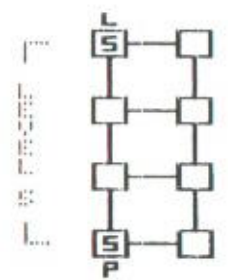

STAFF JONI

7<sup>th</sup>

CODE

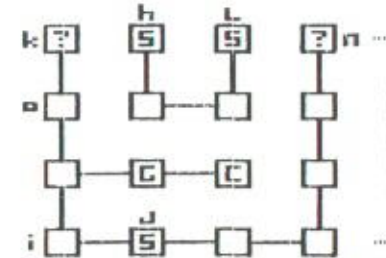
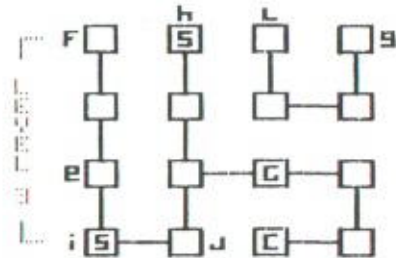
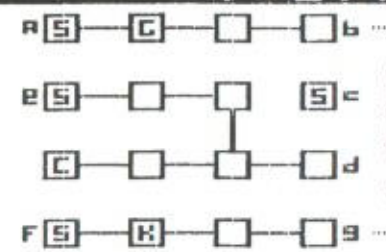
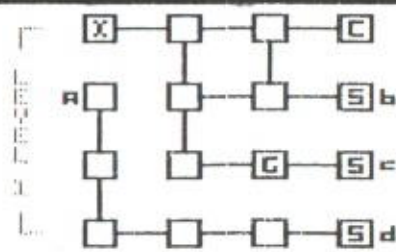

STAFF JONI

7<sup>th</sup>

CODE

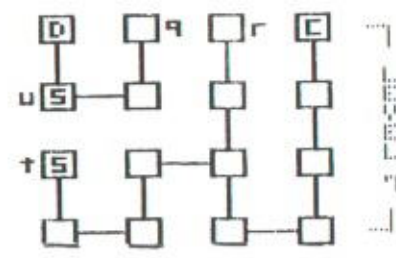
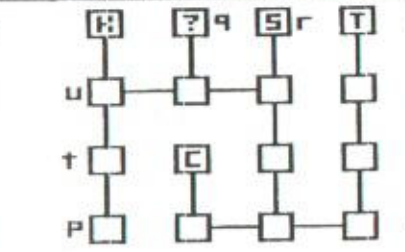
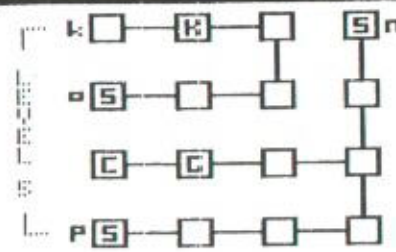

STATION

IB

CODE

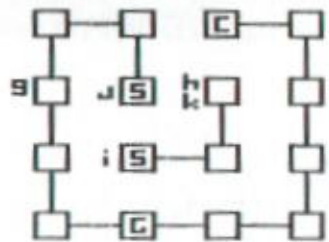
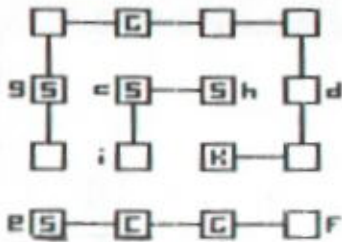
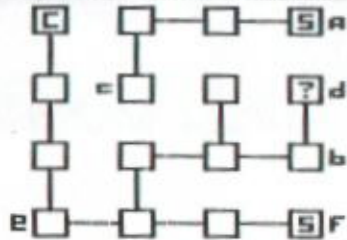
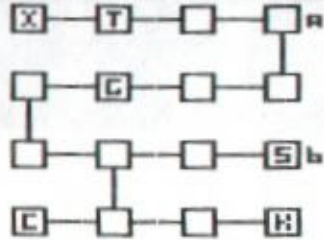

STATION

IB

CODE

